

**User Instructions**

**MSA Cable Temporary Horizontal Lifeline**

**Fall Protection**



Order No.: 10219285 (OSHA), 10235617/03 (Online)

Print Spec: 10000005389 (EO)

CR: 800000065333

**⚠ WARNING!**

These instructions must be provided to users before use of the product and retained for ready reference by the user. Read this manual carefully before using or maintaining the device. The device will perform as designed only if it is used and maintained in accordance with the manufacturer's instructions. Otherwise, it could fail to perform as designed, and persons who rely on this device could sustain serious injury or death.

---

The warranties made by MSA with respect to the product are voided if the product is not installed and used in accordance with the instructions in this manual. Please protect yourself and your employees by following the instructions.

Please read and observe the WARNINGS and CAUTIONS inside. For additional information relative to use or repair, call 1-800-MSA-2222 during regular working hours.

MSA is a registered trademark of MSA Technology, LLC in the US, Europe and other Countries. For all other trademarks visit <https://us.msasafety.com/Trademarks>.



*The Safety Company*

1000 Cranberry Woods Drive  
Cranberry Township, PA 16066  
USA  
Phone: 1-800-MSA-2222  
Fax: 1-800-967-0398

For your local MSA contacts, please go to our website [www.MSAsafety.com](http://www.MSAsafety.com)

# Contents

<b>1</b>	<b>Safety Regulations</b> .....	<b>4</b>
<b>2</b>	<b>Description</b> .....	<b>7</b>
	2.1 Application .....	7
	2.2 Function .....	7
	2.3 Product Overview .....	7
<b>3</b>	<b>Product Specification</b> .....	<b>8</b>
<b>4</b>	<b>Installation and Use</b> .....	<b>9</b>
<b>5</b>	<b>Operation</b> .....	<b>11</b>
<b>6</b>	<b>System Tension Release</b> .....	<b>11</b>
<b>7</b>	<b>Care, Maintenance, and Storage</b> .....	<b>12</b>
<b>8</b>	<b>Pre-Use Checks and Periodic Examination</b> .....	<b>12</b>
	8.1 Periodic Examination Checklist .....	15
<b>9</b>	<b>Fall Clearance Charts</b> .....	<b>16</b>
<b>10</b>	<b>Warranty</b> .....	<b>19</b>

### 1 Safety Regulations

#### **WARNING!**

##### General Requirements

- Users must obey all applicable standards and regulations. Temporary horizontal lifeline (THLL) systems shall be installed and used under the supervision of a Qualified Person \* as part of a complete personal fall arrest system that maintains a safety factor of at least two. DO NOT exceed the allowable free fall distance or maximum fall arrest forces specified by governing standards or subsystem components.
  - \* **Qualified Person:** An individual with a recognized degree or professional certificate, and extensive knowledge and experience in the subject field, who is capable of design, analysis, evaluation, and specification in the subject work, project, or product. Refer to OSHA 1910.140, 1926.32, and 1926.502.
- This product is part of a fall protection system. National standards and state, provincial, and federal laws require the user to be trained before using this product. Use this manual as part of a user safety training program that is appropriate for the user's occupation. These instructions must be provided to users before use of the product and retained for ready reference by the user. The user must read, understand (or have explained), and obey all instructions, labels, markings, and warnings supplied with this product and with other products intended for use in association with this product. If this personal protective equipment (PPE) is resold, it is essential that the instructions for use, maintenance, and periodic examination are provided in the language of destination.
- Store the product per the instructions. Improper storage may lead to damage of critical components.

##### User Requirements

- Users shall be medically fit and suitably trained.
- THLL shall not be used by pregnant people, minors, or those under the influence of alcohol or drugs.
- The maximum number of users for the system is two. The maximum weight of each user is 310 lbs (141 kg) including user, tools, and clothing.

##### Anchor Requirements / Swing Fall / Fall Clearances

- Anchorages must be capable of supporting the required load. See Section [3 Product Specification](#) for details on anchorage strength.
- Follow instructions provided with optional anchor slings to identify correct usage cases. DO NOT use anchor slings for purposes other than those for which they are designed.
- Ensure the available fall clearance is greater than the fall clearance shown in Section [9 Fall Clearance Charts](#) plus swing fall allowances determined by the Qualified Person.
- Prevent swing falls and impact with objects in or adjacent to the fall path. Keep work area free from debris, obstructions, trip hazards, spills or other hazards which could impair the safe operation of the fall protection system. Swing falls occur when the anchor point is not directly in-line with the user. The force of striking an object in a pendular (swinging) motion can cause serious injury. Always minimize swing falls by working in-line with the bypass shuttles as much as possible. Swing falls can increase clearance requirements. For potential swing fall scenarios DO NOT use the device until a Qualified Person has inspected the workplace for potential swing fall hazards and additional clearance requirements. Always remove obstructions below the work area to ensure a clear fall path.

##### Product Use

- THLL systems are only to be used for their intended purpose and within their limitations. DO NOT intentionally misuse this product. DO NOT use fall protection equipment for purposes other than those for which it is designed. DO NOT use fall protection equipment for towing, hoisting, or material handling.
- THLL systems shall not be altered or added to. No unauthorized repairs, modifications, alterations and/or additions are permitted.
- RESCUE AND EVACUATION: The user must have a rescue plan and the means at hand to implement it. The plan must take into account the equipment and specific training necessary to affect prompt rescue under all foreseeable conditions. If the rescue must be performed in a confined space, the provisions of OSHA regulation 1910.146 and ANSI Z117.1 must be taken into account. It is recommended to provide means for user evacuation without

assistance of others. This will usually reduce the time to get to a safe place and reduce or prevent the risk to rescuers.

- Use only compatible components, connectors, and subsystems with this equipment. The use of non-approved components, connectors, or subsystems can put the safety and reliability of the complete system at risk. DO NOT change the design or configuration of the MSA Cable THLL or intentionally use it incorrectly.
- DO NOT rely on feel or sound to verify proper snaphook or carabiner engagement. Ensure that gate and keeper are closed before use.
- Avoid applying load to the carabiner gates. Additionally, avoid situations likely to reduce the connector's resistance, such as junctions with wide straps, use in leverage positions, use with load positioned on its minor axis, and use with the connector gate open.
- Remove any surface contamination such as, but not limited to, concrete, stucco, roofing material, etc. that could accelerate cutting or abrading of attached components.
- DO NOT use system adjacent to moving machinery, electrical hazards, or in the presence of excessive heat, open flame, or molten metal. DO NOT use the system in an environment where temperatures exceed 140°F (60°C).
- DO NOT leave the THLL installed in environments which could cause damage or deterioration to the product. Refer to Section 8 [Pre-Use Checks and Periodic Examination](#) and Section 7 [Care, Maintenance, and Storage](#) for inspection and care details.
- During installation and removal of the MSA Cable THLL, prevent exposure to fall hazards. If necessary, use an aerial work platform. During installation and removal of the MSA Cable THLL at height, take necessary precautions to prevent MSA Cable THLL components from falling from height.
- During installation, the line should be set up as close to horizontal as the work environment allows with a maximum acceptable line angle of +/- 5 degrees.
- Follow tensioning guidelines in instructions. Over-tensioning the lifeline could initiate tear-out of energy absorber or in the event of a fall overload end anchors. Under-tensioning of the system will result in an increased arrest distance.
- When a user falls while connected to the MSA Cable THLL system, the wire rope will deflect within the span to which the user is connected. If two users are connected to the system and one user falls, the second user can be pulled off the work surface because of the deflection of the MSA Cable THLL. The possibility that the second user will fall increases as the MSA Cable THLL span length increases.

### **Leading Edge-Specific Product Use**

- Use in edge situations should only be as a last resort.
- Leading edge configurations shall only be used after all other hierarchy of controls, including restraint systems and overhead anchorages, have been exhausted.
- Prior to use, leading edges must be evaluated by a Qualified Person.
- Use only leading edge rated PPE with the THLL when leading edge hazards exist.
- DO NOT use where the horizontal lifeline could abrade against sharp, jagged, or abrasive edges.
- Avoid working where the leading edge rated PPE lifeline will continuously or repeatedly abrade against sharp, jagged, or abrasive edges.
- If the risk assessment indicates that an edge could damage the horizontal lifeline or leading edge PPE lifelines then eliminate such contact or protect the edges using a pad or other means before the start of work.

### **Inspection / Removing Product from Service**

- Examine all components of connecting subsystems used with the MSA Cable THLL according to the manufacturer instructions.
- Perform inspections more frequently in corrosive or extreme weather environments.
- The MSA Cable THLL shall not be altered or added to. No unauthorized repairs, modifications, alterations and/or additions are permitted.
- If the MSA Cable THLL is damaged or has been subjected to fall arrest forces or impact forces, it must be immediately removed from service and tagged "UNUSABLE" until it has been destroyed and disposed of in accordance with local regulations.

## 1 Safety Regulations

---

- Should any doubt arise about its condition for safe use the MSA Cable THLL shall be withdrawn from use immediately and not used again until confirmed in writing by a competent person that it is acceptable to do so.
- Vertical force applied to the lifeline may be indicated by elongation of the energy absorber. In more extreme cases, the white sections of tear webbing will become visible from the hook end of the energy absorber case. It is difficult to determine how much energy absorption remains in a partially deployed unit. Immediately remove the THLL from service and mark it as "UNUSABLE" until it has been destroyed and disposed of in accordance with local regulations.

**Failure to follow these warnings can result in serious personal injury or death.**

## 2 Description

### 2.1 Application

The MSA Cable Temporary Horizontal Lifeline (THLL) is a cable system that can be suspended between two approved anchorage points to provide worker fall protection during horizontal movement. Applications include buildings, bridges, scaffolds, steel erection, and other elevated work stations.

### 2.2 Function

This product is intended to be used as a temporary horizontal lifeline as means of anchorage. Lifeline tension and adjustment is achieved using a combination of the cable clamp to pull slack out of the line, turnbuckle for greater tension and the tension indicator to check the correct tension has been achieved. An integral synthetic energy absorber reduces the maximum arrest load acting on the anchorages which prevents damage to the system and anchorages.

### 2.3 Product Overview

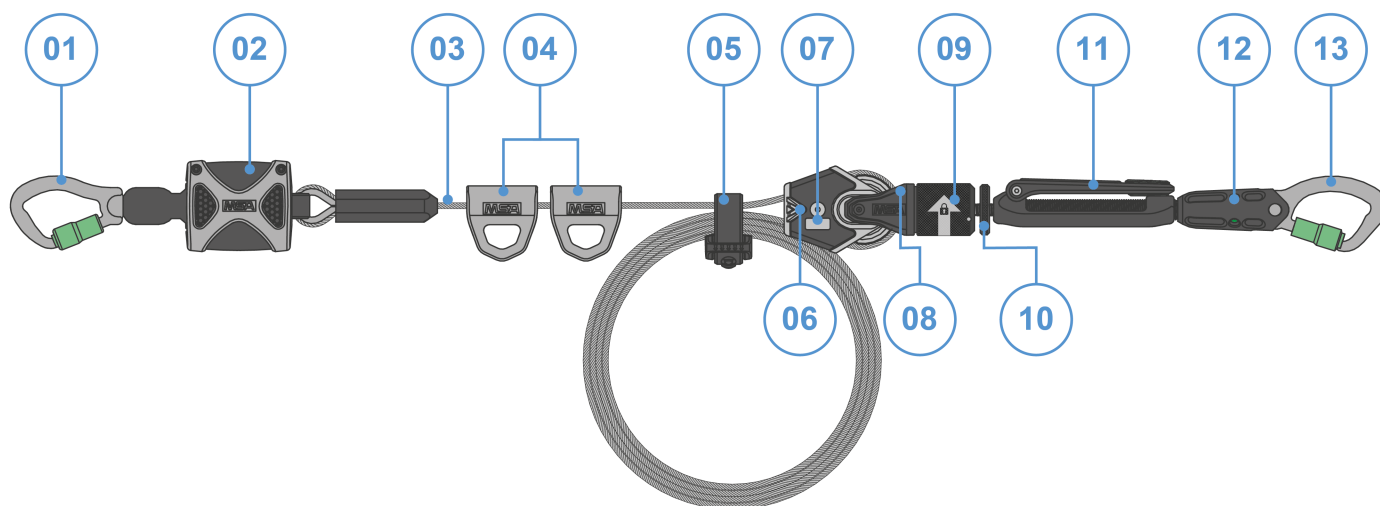

1	Aluminum swivel carabiner	8	RFID
2	Energy absorber	9	Cable lock
3	Lifeline	10	Tension lock nut
4	Bypass shuttle	11	Turnbuckle
5	Cable end stop + cable wrap	12	Tension indicator
6	Cable clamp	13	Aluminum carabiner
7	Manufacture date, serial number, part number		

## 3 Product Specification

### Standards Compliance

- OSHA 29 CFR 1910.140/1926.502 – **2 users** – 5 ft to 100 ft (1.5 m to 30.5 m)

8 ft (2.4 m) System	60 ft (18.3 m) System	100 ft (30.5 m) System
<b>Max Users:</b> 2	<b>Max Users:</b> 2	<b>Max Users:</b> 2
<b>Capacity:</b> 310 lbs (141 kg) per person, including user, tools and clothing	<b>Capacity:</b> 310 lbs (141 kg) per person, including user, tools and clothing	<b>Capacity:</b> 310 lbs (141 kg) per person, including user, tools and clothing
<b>Product Weight:</b> 12 lbs (5.5 kg)	<b>Product Weight:</b> 19.8 lbs (9.0 kg)	<b>Product Weight:</b> 25.6 lbs (11.6 kg)
<b>Max. Length:</b> 8 ft (2.4 m)	<b>Max. Length:</b> 60 ft (18.3 m)	<b>Max. Length:</b> 100 ft (30.5 m)

### Additional Product Design Information:

- Anchorage arrest load will not exceed 2,460 lbs (11.0 kN) when used in accordance to these instructions.
- Allowing a 2:1 safety factor, end anchorages must be capable of sustaining a force of 5,000 lbs (22.2 kN) without deformation in directions permitted by the system and must be certified by an engineer in writing.
- To reduce total fall distance place anchorages at the same level or above workers harness attachment point.
- When using an anchor sling wrapped around vertical columns, ensure the sling is protected from sharp or abrasive edges.

### **WARNING!**

Follow instructions provided with optional anchor slings to identify correct usage cases. **DO NOT** use anchor slings for purposes other than those for which they are designed.

**Failure to follow this warning can result in serious personal injury or death.**

- The MSA Cable THLL will absorb the force of a fall primarily through the energy absorber and personal shock absorber. Total fall distance will increase as the lifeline span increases and if a second worker is added to the system. The fall clearance diagram in [9 Fall Clearance Charts](#) shows the minimum clearance required between the level of the lifeline and the highest obstacle below the system. The fall clearance values in the diagram do not include allowances for swing fall.
- Use of non-MSA components, connectors, and subsystems (including, but not limited to, stanchions, anchorage connectors, harnesses, energy absorbing lanyards, PFLs and SRLs) is only allowed with approval from a Qualified Person. The clearance values given in [9 Fall Clearance Charts](#) **DO NOT APPLY** if non-MSA components, connectors, and subsystems are used. It is the responsibility of the Qualified Person to verify compatibility and strength of all non-MSA components, connectors, and subsystems (including, but not limited to, stanchions, anchorage connectors, harnesses, energy absorbing lanyards, PFLs and SRLs) and provide the minimum clearance requirements.
- Personal Fall Arrest System must be attached directly to lifeline or bypass shuttle with a locking snaphook or carabiner only. For applications that do not require the use of bypass shuttles, users may attach directly to the lifeline with approved connectors, that require two separate, consecutive and deliberate manual actions to be detached and are compliant with all applicable standards and regulations in the country or region of use. All MSA retractable type fall arrester (RTFA) up to a length of 50 ft (15 m) are compatible for direct use.



Component	Material
Carabiners	Aluminum
Energy Absorber Cover	Polycarbonate
Lifeline	0.3125" (8 mm) 6x19 fiber core galvanized steel cable <ul style="list-style-type: none"> <li>• Lifeline cross sectional area: 0.042 in<sup>2</sup> (27.52 mm<sup>2</sup>)</li> <li>• Lifeline tensile strength: 1770 MPa (256,716 psi)</li> </ul>
Energy Absorber	1.65" (42 mm) Natural Polyester <ul style="list-style-type: none"> <li>• Minimum breaking strength: 6,744 lbs (30 kN)</li> <li>• Maximum deployment force: 2,460 lbs (11.0 kN)</li> <li>• Average deployment force: 1600 lbs (7 kN)</li> <li>• Maximum deployment: 49 in (1.25 m)</li> </ul>
Turnbuckle	Steel and aluminum
Backup Strap	1.65" (42 mm) Dyneema® webbing
Tension Indicator	Aluminum
Cable Clamp	Steel and aluminum
Bypass Shuttles	Steel

## 4 Installation and Use

### **⚠ WARNING!**

- The MSA Cable THLL shall not be altered or added to. No unauthorized repairs, modifications, alterations and/or additions are permitted.
- Ensure the available fall clearance is greater than the fall clearance shown in Section 1 Fall Clearance Charts plus swing fall allowances determined by the Qualified Person.
- During installation and removal of the MSA Cable THLL, prevent exposure to fall hazards. If necessary, use an aerial work platform. During installation and removal of the MSA Cable THLL at height, take necessary precautions to prevent MSA Cable THLL components from falling from height.
- During installation, the line should be set up as close to horizontal as the work environment allows with a maximum acceptable line angle of +/- 5 degrees.

**Failure to follow these warnings can result in serious personal injury or death.**

1. Complete the appropriate actions in Section [8 Pre-Use Checks and Periodic Examination](#)

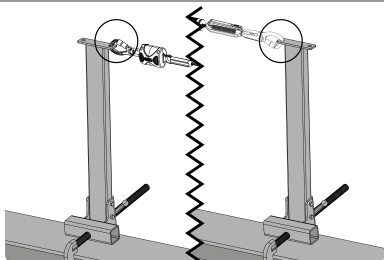

2. Identify suitable end anchors. This includes stanchions, heavy duty D-rings, suitably drilled I-beams, anchor slings, etc.

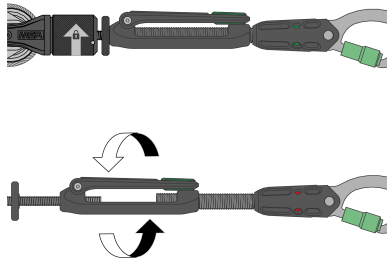

3. Uncoil cable and unwind turnbuckle.

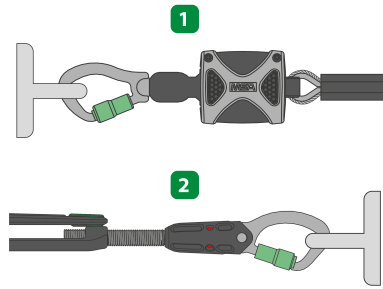

4. Connect energy absorber end of lifeline to anchorage point first [1], followed by the turnbuckle end [2].

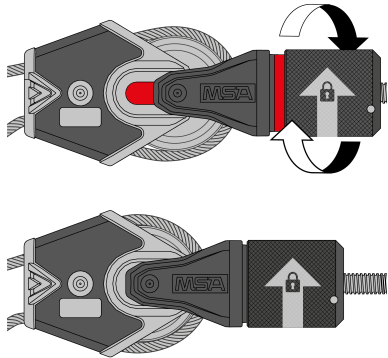

5. Pull slack out of the system and lock the tension by tightening the cable lock until it can no longer turn. The tension is locked when the cable lock cannot turn any further and the two red indicators are no longer visible.

**⚠ WARNING!**

Do not use the MSA Cable THLL if any red is visible on either cable lock indicator.

**Failure to follow this warning can result in serious personal injury or death.**

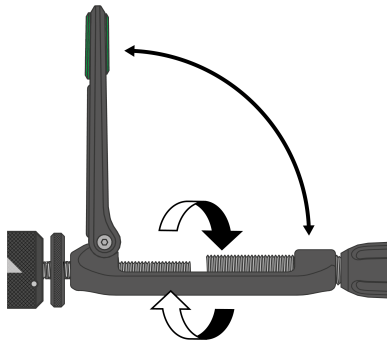

6. With cable clamp locked, start tensioning the system using the turnbuckle. Fold out handle to apply final tensioning force by rotating the turnbuckle as shown.

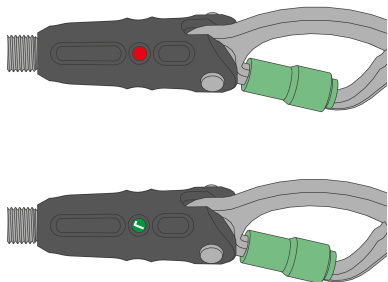

7. Check tension indicator.

**Red indicator**—Not tensioned

**Split red/green indicator**—Partial tension

**Green indicator with check mark**—Correct tension

**NOTE:** When the MSA Cable THLL is properly tensioned, the check mark displays in the middle of the tension indicator window.

**⚠ WARNING!**

Do not use the MSA Cable THLL if any red is visible on the tension indicator.

**Failure to follow this warning can result in serious personal injury or death.**

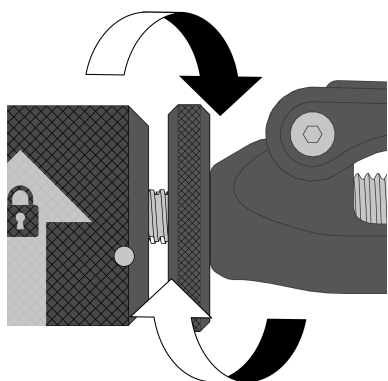

8. Turn lock nut toward the turnbuckle.

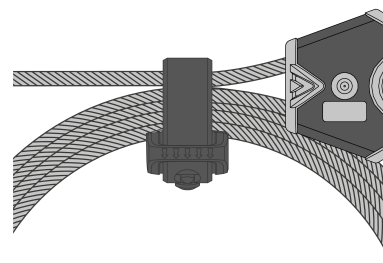

9. Use cable wrap to coil the unused cable and hang from lifeline.

10. In cases where the lifeline has already been installed, complete Step 7 before each use. Check the tension indicator to confirm the indicator is green and no red is showing, ensuring proper tension.

## 5 Operation

To bypass another worker on the same horizontal lifeline, orient the bypass shuttles so one bypass shuttle can slide past the other as shown in the figures below.

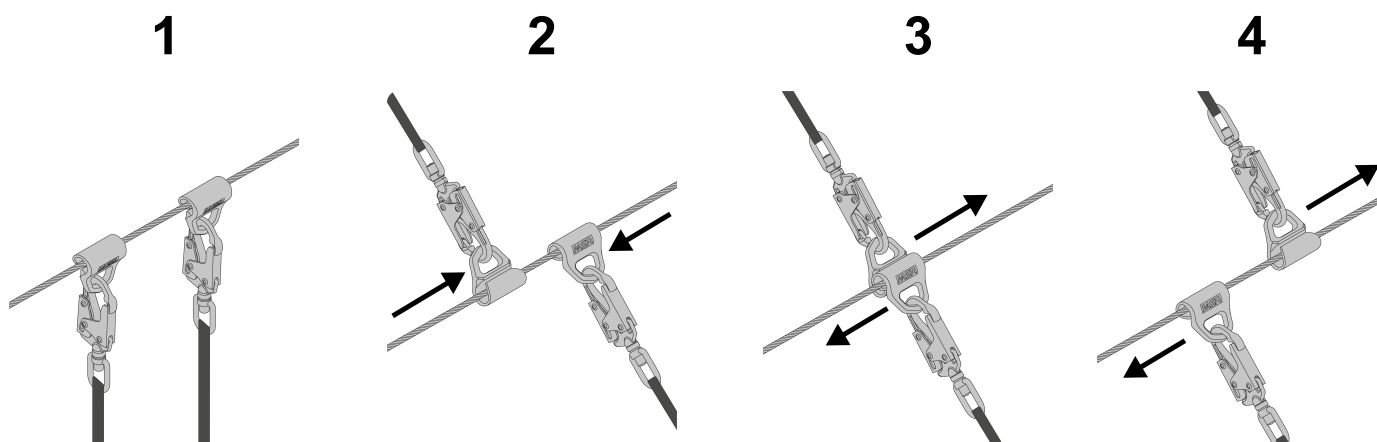

## 6 System Tension Release

1. Disengage tension lock nut.
2. Unwind turnbuckle until tension indicator window displays red.
3. Release cable lock by turning cable lock counterclockwise. Do not hold onto the lifeline when de-tensioning.
4. Disconnect system from anchor points.
5. Pull cable wrap end of the lifeline so the swage boot/ energy absorber are touching the cable clamp.
6. Rotate turnbuckle until threads are fully retracted into turnbuckle.
7. Coil the cable and secure with cable wrap.
8. Store in accordance with care, maintenance, and storage guidance. See [7 Care, Maintenance, and Storage](#).

### 7 Care, Maintenance, and Storage

If required, the THLL turnbuckle, lifeline and connectors may be cleaned using a damp cloth and warm water (max 105°F / 40°C) and allowed to dry naturally before use. Excessive build-up of dirt, paint, etc. can compromise both line tension and strength of the system.

Product must be stored in a cool, dry, clean environment, away from heat, steam, harmful fumes, corrosive agents, rodents, dust, oil, and direct sunlight. During transportation, the device shall be protected to prevent damage or contamination. Examine the THLL after long periods of storage prior to returning it to service.

Lubricate threads with a light oil to maintain good working order and to protect against corrosion. Follow lubricant manufacturer's instruction. Do not over-lubricate. Wipe excess with a clean, dry cloth.

#### **WARNING!**

Store the product per the instructions. Improper storage may lead to damage of critical components.

**Failure to follow this warning can result in serious personal injury or death.**

---

### 8 Pre-Use Checks and Periodic Examination

#### **WARNING!**

- Examine all components of connecting subsystems used with the MSA Cable THLL according to the manufacturer instructions.
- Perform inspections more frequently in corrosive or extreme weather environments.
- The MSA Cable THLL shall not be altered or added to. No unauthorized repairs, modifications, alterations and/or additions are permitted.
- If the MSA Cable THLL is damaged or has been subjected to fall arrest forces or impact forces, it must be immediately removed from service and tagged "UNUSABLE" until it has been destroyed and disposed of in accordance with local regulations.
- Vertical force applied to the lifeline may be indicated by elongation of the energy absorber. In more extreme cases, the white sections of tear webbing will become visible from the hook end of the energy absorber case. It is difficult to determine how much energy absorption remains in a partially deployed unit. Immediately remove the THLL from service and mark it as "UNUSABLE" until it has been destroyed and disposed of in accordance with local regulations.
- Should any doubt arise about its condition for safe use the MSA Cable THLL shall be withdrawn from use immediately and not used again until confirmed in writing by a competent person that it is acceptable to do so.

**Failure to follow these warnings can result in serious personal injury or death.**

---

**Pre-Installation Checks** shall occur before each installation of the MSA Cable THLL to ensure the THLL is in suitable condition for use. See [Table 1 Pre-Installation Checks](#) for examinations that must be completed before installation.

**Pre-Use Checks** shall occur after the THLL has been installed and before each time a user connects to the THLL. The safety of the user relies upon the continued efficiency and durability of the equipment. See [Table 2 Pre-Use Checks](#) for pre-use check information.

**Periodic Examinations** shall be completed by a person, other than the user, competent in the examination of THLLs, in accordance with the manufacturer's instructions. The interval will be dictated by the usage, local regulations, and environmental conditions, and will be at least annually. See [Table 3 Periodic Examination Interval](#) and [Section 8.1 Periodic Examination Checklist](#) for more information. A record shall be kept of the results of the examination.

Table 1 Pre-Installation Checks



Component	Method	
Cable Clamp Indicators	Inspect the cable clamp indicators for signs of dirt ingress	
Connectors	Check for correct operation of connector and connector gate.	

Table 2 Pre-Use Checks

Component	Method	
Labels	Ensure labels are present and legible.	
Examination Date	Ensure date of next examination has not elapsed. Ensure a periodic examination is not due as determined by a competent person. See table below for examination interval.	
Load Indicator	Ensure load indicator has not been deployed by examining for white tear webbing protruding from energy absorber cover (indicates excessive force applied).	
General Condition and Lifeline	Inspect for tears, cuts, signs of chemical damage, crushing, excessive soiling, or heavy contamination ingress.  Inspect the entire lifeline for kinks, broken strands, damaged splices or thimbles. Damaged cable can fail at much lower forces than expected.	
Energy Absorber Connection Points	Ensure there is no fraying, abrasion, damaged stitching, stiffness, melting, chemical attack or excessive soiling.	
Hardware Elements	Examine for cracks, sharp edges, deformation, corrosion, chemical attack, excessive heating or excessive wear.	
Tension Indicator	Review the tension indicator prior to each use. When the MSA Cable THLL is properly tensioned, the check mark displays in the middle of the tension indicator window.	
Steel Anchor Slings (optional)	If using steel anchor slings, inspect for severe kinking, missing thimbles, broken strands, or damaged swages.	

## 8 Pre-Use Checks and Periodic Examination

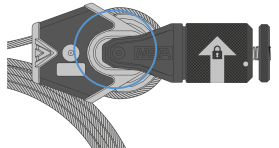
---

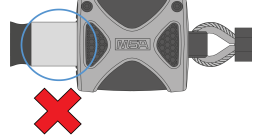
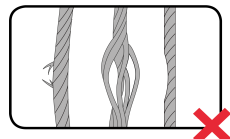
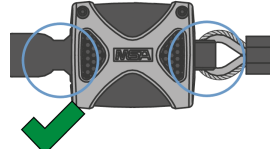
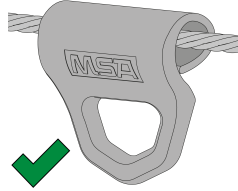
*Table 3 Periodic Examination Interval*

MSA recommends that the product is directly marked with the date of the next or last Periodic Inspection.

<b>Usage</b>	<b>Interval</b>
Infrequent to light	Annually (12 months)
Moderate to heavy	Semi-annually to annually (6-12 months)
Severe to continuous	Quarterly to semi-annually (3-6 months)

Usage shall be determined by a competent person. A competent person is defined as a person, other than the user, competent in the examination of PPE in accordance with MSA instructions.

---

8.1 Periodic Examination Checklist

Model Number: \_\_\_\_\_ Serial Number: \_\_\_\_\_  
 Date: \_\_\_\_\_ Inspector (Name / Signature): \_\_\_\_\_  
 Date of Manufacture: \_\_\_\_\_ Date of Purchase: \_\_\_\_\_  
 Date of First Use: \_\_\_\_\_ Date Due for Next Periodic Inspection: \_\_\_\_\_

#	Description	Good— Safe for Use	Good— Safe for Use	Good— Safe for Use	Good— Safe for Use	Good— Safe for Use	Good— Safe for Use	Damaged, Worn, Altered, Missing— Remove from Service	Comments
<b>Connectors</b>									
1	Aluminum swivel carabiner								
12	Aluminum carabiner								
<b>Energy Absorber &amp; Lifeline Components</b>									
2	Energy absorber								
3	Lifeline								
5	Cable end stop + cable wrap								
<b>Hardware Components</b>									
4	Bypass shuttle								
6	Cable clamp								
8	Cable lock								
9	Tension lock nut								
10	Turnbuckle								
11	Tension indicator								
<b>Labels</b>									
7	Manufacture date, serial number, part number, warning								
	Steel anchorage sling (2), optional								

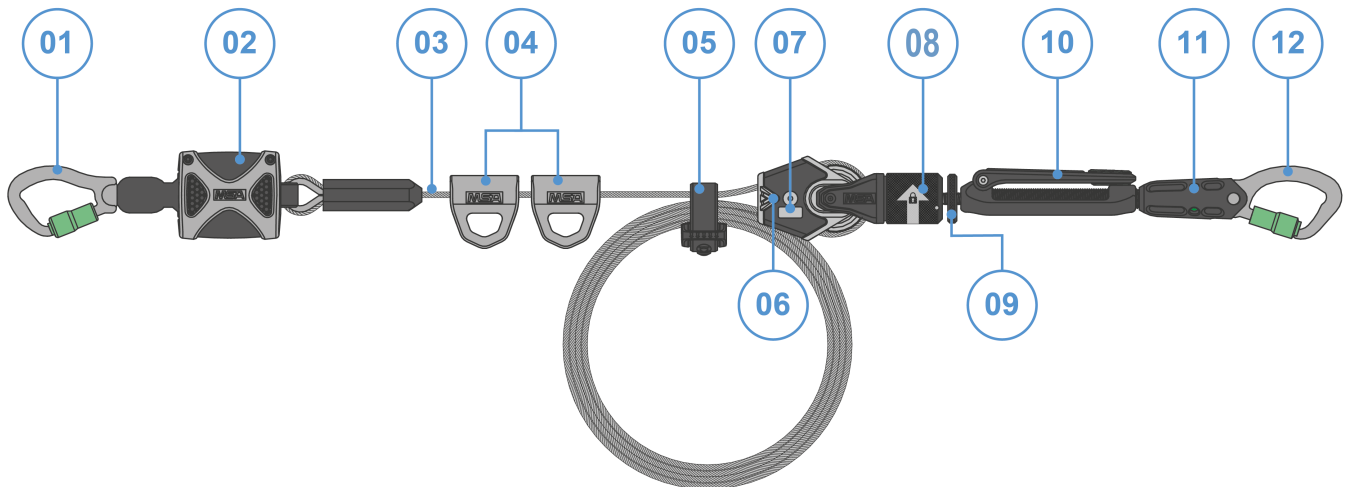

## 9 Fall Clearance Charts

## CALCULATING TOTAL FALL CLEARANCE

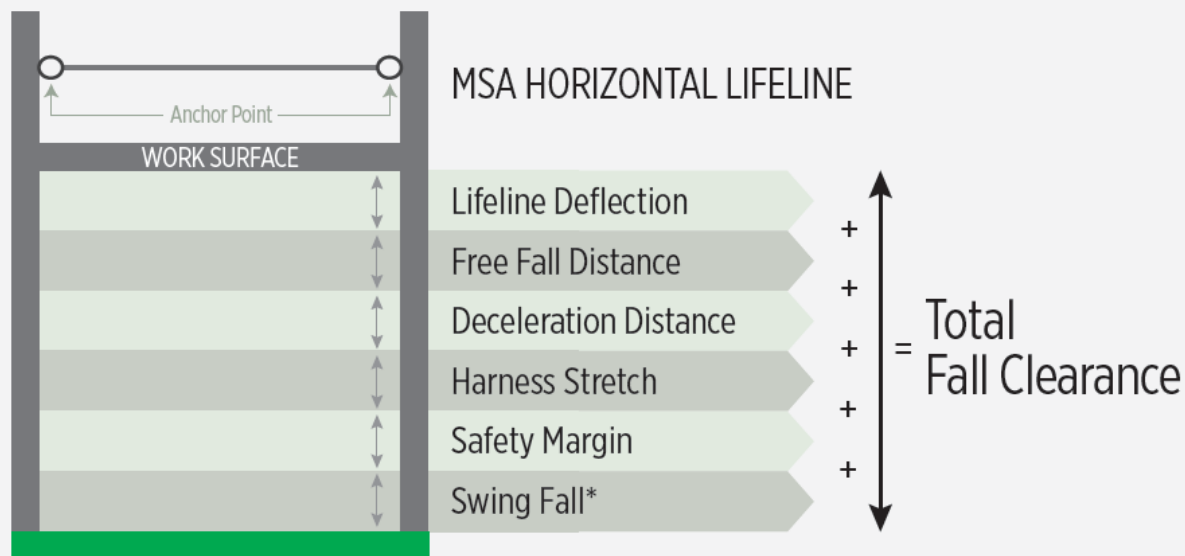

### ⚠ WARNING!

\*Additional clearance for swing fall is NOT included in the charts provided. Prevent swing falls and impact with objects in or adjacent to the fall path. Keep work area free from debris, obstructions, trip hazards, spills or other hazards which could impair the safe operation of the fall protection system. Swing falls occur when the anchor point is not directly in-line with the user. The force of striking an object in a pendular (swinging) motion can cause serious injury. Always minimize swing falls by working in-line with the bypass shuttles as much as possible. Swing falls can increase clearance requirements. For potential swing fall scenarios DO NOT use the device until a Qualified Person has inspected the workplace for potential swing fall hazards and additional clearance requirements. Always remove obstructions below the work area to ensure a clear fall path.

- Use in edge situations should only be as a last resort.
- Leading edge configurations shall only be used after all other hierarchy of controls, including restraint systems and overhead anchorages, have been exhausted.
- Prior to use, leading edges must be evaluated by a Qualified Person.
- Use only leading edge rated PPE with the THLL when leading edge hazards exist.
- DO NOT use where the horizontal lifeline could abrade against sharp, jagged, or abrasive edges.
- Avoid working where the leading edge rated PPE lifeline will continuously or repeatedly abrade against sharp, jagged, or abrasive edges.
- If the risk assessment indicates that an edge could damage the horizontal lifeline or leading edge PPE lifelines then eliminate such contact or protect the edges using a pad or other means before the start of work.
- The fall clearance charts in this manual are based upon use with MSA components, connectors, and subsystems (including, but not limited to, stanchions, anchorage connectors, harnesses, energy absorbing lanyards, PFLs and SRLs). The clearance values given in this section DO NOT APPLY if non-MSA components, connectors, and subsystems are used. Use of non-MSA components, connectors, and subsystems (including, but not limited to, stanchions, anchorage connectors, harnesses, energy absorbing lanyards, PFLs and SRLs) is only allowed with approval from a Qualified Person. Do not use non-MSA components unless a Qualified Person has approved their use and provides the minimum clearance requirements based on the specific non-MSA components.



**Failure to follow these warnings can result in serious personal injury or death.**



Imperial Charts



**FLOOR LEVEL ATTACHMENT — 0 to 3 ft.**

\*See swing fall warning above.

		Span Length									
		10 ft.	20 ft.	30 ft.	40 ft.	50 ft.	60 ft.	70 ft.	80 ft.	90 ft.	100 ft.
 <p>1 USER Max. 310 lb.</p>	<b>Connected PPE</b>										
	MSA Leading Edge PFL	15.0	16.5	18.0	19.5	21.0	22.5	23.5	24.5	25.5	26.5
	MSA Leading Edge SRL	14.5	16.0	17.5	19.0	20.5	21.5	23.0	24.0	25.0	26.0
	MSA 6 ft. Energy-Absorbing Leading Edge Lanyard	18.5	20.0	21.0	22.5	24.0	25.5	27.0	28.5	29.5	30.5
		Span Length									
		10 ft.	20 ft.	30 ft.	40 ft.	50 ft.	60 ft.	70 ft.	80 ft.	90 ft.	100 ft.
 <p>2 USERS Max. 620 lb.</p>	<b>Connected PPE</b>										
	MSA Leading Edge PFL	17.0	18.5	20.0	21.5	23.0	24.5	25.5	27.0	28.0	29.0
	MSA Leading Edge SRL	17.0	18.0	19.5	21.0	22.5	24.0	25.0	26.5	27.5	28.5
	MSA 6 ft. Energy-Absorbing Leading Edge Lanyard	21.5	23.0	24.5	26.0	27.0	28.5	30.0	31.5	32.5	33.5



**STANCHION HEIGHT ATTACHMENT — 3 to 6 ft.**

\*See swing fall warning above.

		Span Length									
		10 ft.	20 ft.	30 ft.	40 ft.	50 ft.	60 ft.	70 ft.	80 ft.	90 ft.	100 ft.
 <p>1 USER Max. 310 lb.</p>	<b>Connected PPE</b>										
	MSA Leading Edge PFL	11.0	12.5	14.5	15.5	16.5	18.0	19.0	19.5	20.5	21.5
	MSA Leading Edge SRL	10.5	12.0	13.5	15.0	16.0	17.0	18.0	19.0	20.0	21.0
	MSA 6 ft. Energy-Absorbing Leading Edge Lanyard	14.5	16.0	17.5	19.0	20.5	22.0	23.0	24.0	25.0	26.0
		Span Length									
		10 ft.	20 ft.	30 ft.	40 ft.	50 ft.	60 ft.	70 ft.	80 ft.	90 ft.	100 ft.
 <p>2 USERS Max. 620 lb.</p>	<b>Connected PPE</b>										
	MSA Leading Edge PFL	12.5	14.0	15.5	17.0	18.0	19.0	20.0	21.0	22.0	23.0
	MSA Leading Edge SRL	12.0	13.5	15.0	16.5	17.5	18.5	19.5	20.5	21.5	22.5
	MSA 6 ft. Energy-Absorbing Leading Edge Lanyard	16.5	18.0	19.5	21.0	22.5	24.0	25.5	26.5	27.5	28.5

**OVERHEAD ATTACHMENT — 6 ft.+**

\*See swing fall warning above.



		Span Length									
		10 ft.	20 ft.	30 ft.	40 ft.	50 ft.	60 ft.	70 ft.	80 ft.	90 ft.	100 ft.
 <p>1 USER Max. 310 lb.</p>	<b>Connected PPE</b>										
	MSA Leading Edge PFL	8.5	10.0	11.0	12.0	13.0	14.0	15.0	15.5	16.5	17.0
	MSA Overhead PFL	8.5	10.0	11.0	12.0	13.0	14.0	15.0	15.5	16.5	17.0
	MSA Leading Edge SRL	8.0	9.5	10.5	11.5	12.5	13.5	14.0	15.0	15.5	16.5
	MSA Overhead SRL	7.5	9.0	10.0	11.0	11.5	12.5	13.5	14.0	14.5	15.5
	MSA 6 ft. Energy-Absorbing Leading Edge Lanyard	9.5	11.0	12.5	13.5	14.5	15.5	16.5	17.5	18.0	19.0
 <p>2 USERS Max. 620 lb.</p>	<b>Connected PPE</b>										
	MSA Leading Edge PFL	9.0	11.0	12.0	13.0	14.0	15.0	16.0	17.0	18.0	19.0
	MSA Overhead PFL	9.0	11.0	12.0	13.0	14.0	15.0	16.0	16.5	17.5	18.0
	MSA Leading Edge SRL	8.5	10.0	11.0	12.0	13.0	14.0	15.0	15.5	18.0	19.0
	MSA Overhead SRL	8.0	9.5	10.5	11.5	12.5	13.0	14.0	14.5	17.0	18.0
	MSA 6 ft. Energy-Absorbing Leading Edge Lanyard	10.5	12.0	13.5	14.5	15.5	16.5	17.5	18.5	19.5	20.0
MSA 6 ft. Energy-Absorbing Overhead Lanyard	10.5	12.0	13.5	14.5	15.5	16.5	17.5	20.0	21.0	22.0	

Metric Charts

FLOOR LEVEL ATTACHMENT — 0 m to 0.9 m

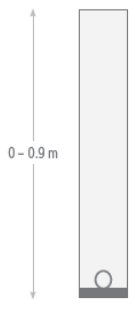
\*See swing fall warning above.





		Span Length									
		3.05 m	6.10 m	9.14 m	12.19 m	15.24 m	18.29 m	21.34 m	24.38 m	27.43 m	30.48 m
1 USER  Max. 141 kg	Connected PPE										
	MSA Leading Edge PFL	4.57	5.03	5.49	5.94	6.40	6.86	7.16	7.47	7.77	8.08
	MSA Leading Edge SRL	4.42	4.88	5.33	5.79	6.25	6.55	7.01	7.32	7.62	7.92
	MSA 6 ft. Energy-Absorbing Leading Edge Lanyard	5.64	6.10	6.40	6.86	7.32	7.77	8.23	8.69	8.99	9.30
		Span Length									
		3.05 m	6.10 m	9.14 m	12.19 m	15.24 m	18.29 m	21.34 m	24.38 m	27.43 m	30.48 m
2 USERS  Max. 281 kg	Connected PPE										
	MSA Leading Edge PFL	5.18	5.64	6.10	6.55	7.01	7.47	7.77	8.23	8.53	8.84
	MSA Leading Edge SRL	5.18	5.49	5.94	6.40	6.86	7.32	7.62	8.08	8.38	8.69
	MSA 6 ft. Energy-Absorbing Leading Edge Lanyard	6.55	7.01	7.47	7.92	8.23	8.69	9.14	9.60	9.91	10.21

STANCHION HEIGHT ATTACHMENT — 0.9 m to 1.8 m

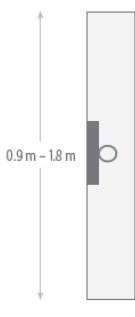
\*See swing fall warning above.





		Span Length									
		3.05 m	6.10 m	9.14 m	12.19 m	15.24 m	18.29 m	21.34 m	24.38 m	27.43 m	30.48 m
1 USER  Max. 141 kg	Connected PPE										
	MSA Leading Edge PFL	3.35	3.81	4.42	4.72	5.03	5.49	5.79	5.94	6.25	6.55
	MSA Leading Edge SRL	3.20	3.66	4.11	4.57	4.88	5.18	5.49	5.79	6.10	6.40
	MSA 6 ft. Energy-Absorbing Leading Edge Lanyard	4.42	4.88	5.33	5.79	6.25	6.71	7.01	7.32	7.62	7.92
		Span Length									
		3.05 m	6.10 m	9.14 m	12.19 m	15.24 m	18.29 m	21.34 m	24.38 m	27.43 m	30.48 m
2 USERS  Max. 281 kg	Connected PPE										
	MSA Leading Edge PFL	3.81	4.27	4.72	5.18	5.49	5.79	6.10	6.40	6.71	7.01
	MSA Leading Edge SRL	3.66	4.11	4.57	5.03	5.33	5.64	5.94	6.25	6.55	6.86
	MSA 6 ft. Energy-Absorbing Leading Edge Lanyard	5.03	5.49	5.94	6.40	6.86	7.32	7.77	8.08	8.38	8.69

OVERHEAD ATTACHMENT — 1.8 m +

\*See swing fall warning above.



		Span Length									
		3.05 m	6.10 m	9.14 m	12.19 m	15.24 m	18.29 m	21.34 m	24.38 m	27.43 m	30.48 m
1 USER  Max. 141 kg	Connected PPE										
	MSA Leading Edge PFL	2.59	3.05	3.35	3.66	3.96	4.27	4.57	4.72	5.03	5.18
	MSA Overhead PFL	2.59	3.05	3.35	3.66	3.96	4.27	4.57	4.72	5.03	5.18
	MSA Leading Edge SRL	2.44	2.90	3.20	3.51	3.81	4.11	4.27	4.57	4.72	5.03
	MSA Overhead SRL	2.29	2.74	3.05	3.35	3.51	3.81	4.11	4.27	4.42	4.72
	MSA 6 ft. Energy-Absorbing Leading Edge Lanyard	2.90	3.35	3.81	4.11	4.42	4.72	5.03	5.33	5.49	5.79
	MSA 6 ft. Energy-Absorbing Overhead Lanyard	2.90	3.35	3.81	4.11	4.42	4.72	5.03	5.33	5.49	5.79
		Span Length									
		3.05 m	6.10 m	9.14 m	12.19 m	15.24 m	18.29 m	21.34 m	24.38 m	27.43 m	30.48 m
2 USERS  Max. 281 kg	Connected PPE										
	MSA Leading Edge PFL	2.74	3.35	3.66	3.96	4.27	4.57	4.88	5.18	5.49	5.79
	MSA Overhead PFL	2.74	3.35	3.66	3.96	4.27	4.57	4.88	5.03	5.33	5.49
	MSA Leading Edge SRL	2.59	3.05	3.35	3.66	3.96	4.27	4.57	4.72	5.49	5.79
	MSA Overhead SRL	2.44	2.90	3.20	3.51	3.81	3.96	4.27	4.42	5.18	5.49
	MSA 6 ft. Energy-Absorbing Leading Edge Lanyard	3.20	3.66	4.11	4.42	4.72	5.03	5.33	5.64	5.94	6.10
	MSA 6 ft. Energy-Absorbing Overhead Lanyard	3.20	3.66	4.11	4.42	4.72	5.03	5.33	6.10	6.40	6.71

## 10 Warranty

**Express Warranty** – MSA warrants that the product furnished is free from mechanical defects or faulty workmanship for a period of one (1) year from first use or eighteen (18) months from date of shipment, whichever occurs first, provided it is maintained and used in accordance with MSA's instructions and/or recommendations. Replacement parts and repairs are warranted for ninety (90) days from the date of repair of the product or sale of the replacement part, whichever occurs first. MSA shall be released from all obligations under this warranty in the event repairs or modifications are made by persons other than its own authorized service personnel or if the warranty claim results from misuse of the product. No agent, employee or representative of MSA may bind MSA to any affirmation, representation or modification of the warranty concerning the goods sold under this contract. MSA makes no warranty concerning components or accessories not manufactured by MSA, but will pass on to the Purchaser all warranties of manufacturers of such components. THIS WARRANTY IS IN LIEU OF ALL OTHER WARRANTIES, EXPRESS, IMPLIED OR STATUTORY, AND IS STRICTLY LIMITED TO THE TERMS HEREOF. MSA SPECIFICALLY DISCLAIMS ANY WARRANTY OF MERCHANTABILITY OR FITNESS FOR A PARTICULAR PURPOSE.

**Exclusive Remedy** – It is expressly agreed that the Purchaser's sole and exclusive remedy for breach of the above warranty, for any tortious conduct of MSA, or for any other cause of action, shall be the repair and/or replacement, at MSA's option, of any equipment or parts thereof, that after examination by MSA are proven to be defective. Replacement equipment and/or parts will be provided at no cost to the Purchaser, F.O.B. Purchaser's named place of destination. Failure of MSA to successfully repair any nonconforming product shall not cause the remedy established hereby to fail of its essential purpose.

**Exclusion of Consequential Damages** – Purchaser specifically understands and agrees that under no circumstances will MSA be liable to Purchaser for economic, special, incidental, or consequential damages or losses of any kind whatsoever, including but not limited to, loss of anticipated profits and any other loss caused by reason of the non-operation of the goods. This exclusion is applicable to claims for breach of warranty, tortious conduct or any other cause of action against MSA.

For additional information, please use your local contacts on our website [www.MSAafety.com](http://www.MSAafety.com).